



FAG



Expertise in Bearing Technology and Service for Rail Vehicles

SCHAEFFLER



Together we move the world ...

Schaeffler Group Industrial, known for its brands INA and FAG, is one of the world's leading manufacturers of rolling bearings and plain bearings. Perfectly-matched solutions for every bearing application in rail vehicles are created in close collaboration with manufacturers and operators. Axlebox bearings and housings, bearings and components for traction motors and gearboxes, for railcar connectors and tilting technology, as well as doors and sliding walls are all part of our product range.

Bearing supports for rail vehicles are exposed to extreme loads and subject to high safety standards. Schaeffler Group Industrial has more than 100 years of experience in railway applications. This means it offers comprehensive technical expertise, high quality, and products that are perfectly matched for every application. The reliability of the bearings under extreme conditions

is tested on test rigs developed in-house. The railway test facility for testing rail vehicle bearings at FAG's plant in Schweinfurt is recognized and certified by the Federal Railway Authority (EBA). In addition, it is also authorized to carry out "performance testing for axlebox bearings – railway applications" in accordance with DIN EN ISO/IEC 17025:2000.

Our services include expert advice on applications, comprehensive design expertise, rolling bearing calculation, and testing. A close-knit network of external sales engineers, service and sales technicians work for you around the world, which ensures customer proximity and fast reaction times.

The Schaeffler Group subsidiary company, FAG Industrial Services (F^{IS}) offers special services such as professional and economic railway bearing reconditioning.

Drive Systems	4
Rolling Bearings for Gearboxes, Traction Motors, Axle Suspension Bearing Supports	5
Running Gear	7
Axlebox Bearings	8
Bearings for Tilting Technology	10
Bearings for Automatic Gage Adjustment Mechanisms ..	12
Bearings for Brake Systems	13
Mechatronics	14
Axlebox Bearings with Integrated Generators	15
Axlebox Bearings with Integrated Sensors	15
Vehicle Bodies	16
Bearings for Connecting Railcar Bodies and Bogies as well as Railcar Bodies with each other	17
Bearings for Door Systems	19
Examples of Application	21
Service	25
Testing Center and Test Rigs	26
Mounting, Tools and Lubricants	28
Railway Bearing Maintenance	29
Quality Management and Certification	30



Modern rail vehicles combine a high level of traveling comfort economically with low noise disturbance and high performance. Rolling bearings manufactured by Schaeffler Group Industrial in gearboxes, traction motors and axle suspension bearing supports make an important contribution to this. Whether for locomotives, power cars and multiple units or light rail vehicles – FAG bearing solutions for drive systems are especially designed for the application in question.

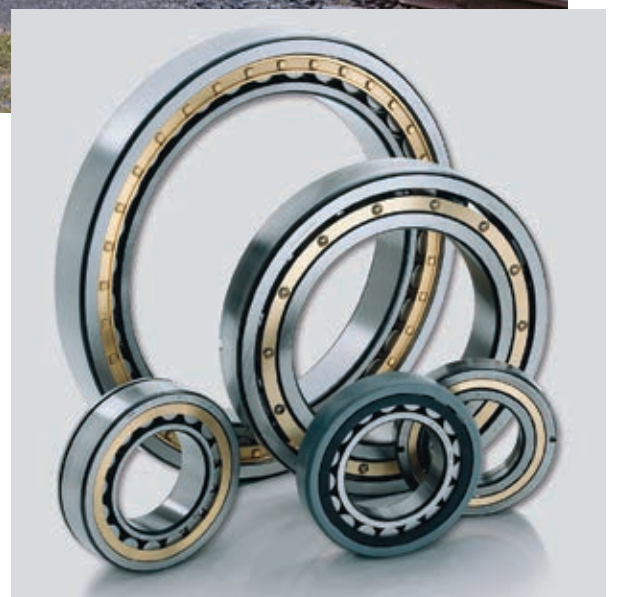

Rolling Bearings for Gearboxes, Traction Motors, Axle Suspension Bearing Supports

Gearbox Bearings

Rolling bearings in gearboxes stabilize the shaft and support the transmission of forces. This means that they must withstand extreme loads in complex environmental conditions. The bearing types mostly used are tapered roller bearings, four point contact bearings, and cylindrical roller bearings. Less often used are deep groove ball bearings, spherical roller bearings, and angular contact ball bearings. The bearing arrangement demands flexibility. It depends on the design of the gearbox and the operating conditions.

The main requirements of bearings in gearboxes are:

- high speeds
- high loads
- vibrations and shocks
- high temperatures
- high guidance accuracy
- compact designs

The bearings are selected in conjunction with the gearbox manufacturer while taking these factors in consideration. A calculated operating life of more than 1.5 million kilometers is usually a prerequisite.

Characteristic features of FAG gearbox bearings:

- reinforced internal design
- special cage design
- reduced tolerances and adjusted internal clearance
- retaining slots in the outer ring to prevent unintentional rotation

Traction Motor Bearings

Rolling bearings for traction motors must fulfill the challenging requirements placed on them regarding reliability and long operating life. Traction motor bearings developed by Schaeffler Group Industrial are specially designed to meet these requirements. Cylindrical roller bearings and deep groove ball bearings are usually used. The normal calculated operating life for traction motor bearings of more than 2 million kilometers is reached due to:

- special cage design
- reinforced internal design
- adjusted tolerances and internal clearance
- efficient current insulation made of ceramics

Axle Suspension Roller Bearings

In electric freight locomotives two rolling bearings fitted into a housing support the traction motor that is arranged transverse to the direction of travel.

The motor rests directly on the wheelset shaft in these two so-called axle suspension roller bearings.

So that the axle suspension roller bearings achieve long operating life (nominal operating life of over 2 million kilometers), roller bearings with high load carrying capacity are used. High loads caused by vibrations and shocks are supported by special tapered roller bearings with reinforced sheet

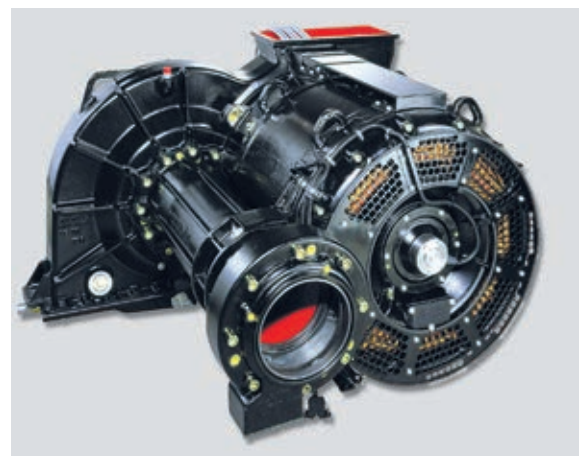

Photo: © 2006, Bombardier Inc. or its subsidiaries. All rights reserved

metal cages. Special designs with collars on the outer rings or with current insulation for example, are also available on request.

Rolling Bearings for Gearboxes, Traction Motors, Axle Suspension Bearing Supports



Tapered Roller Bearings

Tapered roller bearings can be taken apart, since the inner ring with the roller and cage assembly and the outer ring can be assembled separately. The modified linear contact between the rollers and the raceways prevent edge stresses. Tapered roller bearings can support high

radial and axial loads. Since the bearings can only support axial loads in one direction, a second laterally-reversed tapered roller bearing is required for counterstay as well as for supporting internal aligning forces.

Four Point Contact Bearings

Four point contact ball bearings are a type of single-row angular contact ball bearing. They support high axial loads in both directions and are usually mounted with cylindrical roller bearings as well as in a loose radial location. Axial minimum loads are required for low friction, especially for high speeds. The inner ring is split, which means it can accommodate a large number of balls.

Cylindrical Roller Bearings

Single-row cylindrical roller bearings offer an advantage over the other conventional bearing designs because of how easy they are to disassemble in the inner and outer rings with a roller and cage assembly. This offers significant benefits with regards

to mounting, dismounting, maintenance and inspection. Cylindrical roller bearings are particularly suitable for transmitting high radial forces. NJ and NUP cylindrical roller bearings can also partly be used for transmitting axial forces. The modified linear contact between the rollers and the raceways prevent edge stresses.

Current-insulated Bearings

Damage due to excessive voltage can occur in the bearing supports of electric motors under unfavorable conditions. Magnetic asymmetries, which cannot be completely avoided despite careful manufacturing processes, cause the voltage between the rotor and the stator to drop. The electric circuit is then closed via the bearing. To prevent this from happening, Schaeffler Group Industrial supplies innovative solutions, which include inner or outer rings coated with oxide ceramics for breakdown voltages of up to 1,000 V or hybrid bearings with rolling elements made of current-insulated ceramic.



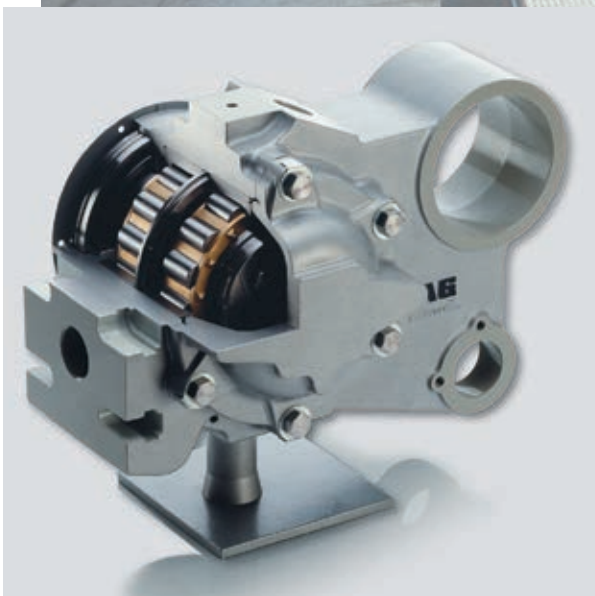

Passengers as well as the operating companies and manufacturers of rail vehicles expect the highest degree of reliability and operating safety, in every type of rail vehicle, from trams to high-speed trains. In light rail vehicles, for example, the focus is on low-floor designs and designs with multiple sections. The running gear, bogies and components must therefore be very compact. Running gear and bogies are components that are important for safety in every rail vehicle. The rolling and plain bearings that Schaeffler Group Industrial develops and manufactures for these applications are specially designed to meet these high standards of quality.

Axlebox Bearings

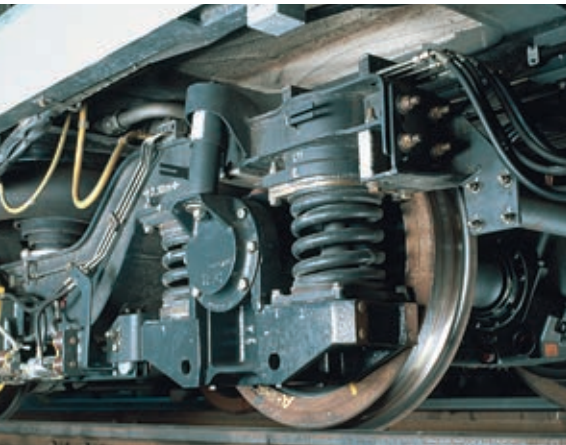

FAG axlebox bearings are subject to extreme loads at the interface between the wheelsets and the bogie frame and have to meet various technical requirements. If the rolling bearing components are tested during a series of tests according to DIN EN 12080, including ultrasonic testing of the inner and outer rings, they comply with the highest quality class and are labeled with “Class 1”. Compliance with DIN EN 12082 is verified on special axlebox bearing test rigs. Axlebox bearings are developed in close

cooperation with manufacturers and rail vehicle operating companies in order to gain products that are optimized for the operating environment in question.

Cylindrical Roller Bearings and Cylindrical Roller Bearing Units

For decades, cylindrical roller bearings have stood the test in the wheelsets of all types of rail vehicles. They are particularly suitable for supporting high radial loads and are usually designed with special internal constructions and polyamide cages for axlebox bearing applications. As well as other axlebox bearings, cylindrical roller bearings (in WJ/WJP standard design or special design) support the usual axial loads. FAG cylindrical roller bearings have a modified linear contact between the rollers and the raceway to prevent edge stresses.

Cylindrical roller bearings in axlebox bearings are principally used in two main configurations:

- two single-row cylindrical roller bearings as a bearing set
- one single-row cylindrical roller bearing as a ready-to-mount unit

Double-row cylindrical roller bearing units have an integrated seal, are greased and are delivered ready to mount. The dimensioning is usually based on a calculated operating life of more than 3 million kilometers.

Spherical Roller Bearings

FAG spherical roller bearings for wheelsets with fixed inner ring flange and solid brass or sheet steel cages withstand the toughest of conditions without any problems. They contain two rows of symmetrical spherical rollers that freely adjust themselves in the concave raceway.

Spherical roller bearings are used in axlebox bearings for freight vehicles, locomotives and other rail vehicles.

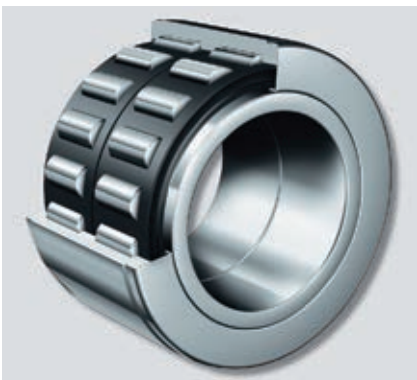

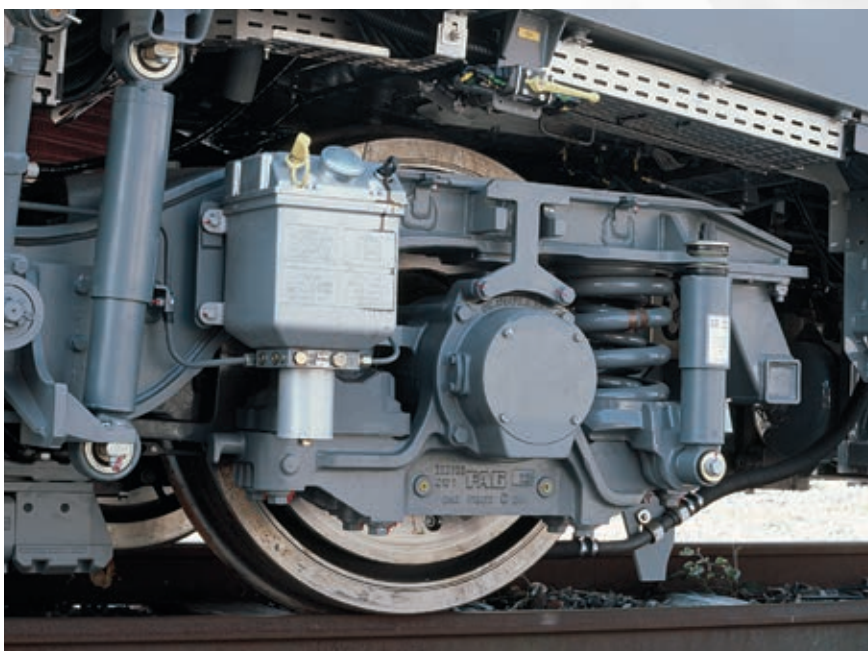

Customer-specific components, spare parts and housing adapters are available on request.

Axlebox Bearing Housing and Adapter

As the connector between the bogie frame and the wheelset, the housing must safely transfer loads. The design depends on how the forces are introduced into the housing. The correct shape ensures optimum distribution of pressure in the rolling bearing so that the specific load is reduced and stress peaks in the load-bearing contact surfaces are avoided. The design of the housing is individually adapted to the adjacent construction.

The optimum design is ensured by means of complex tests that are supported by FEM calculations. The finite element method describes not only complex geometries but also the complex progression of the force flow in the housing as realistically as possible. Axlebox bearing housings and adapters can be supplied made from spheroidal graphite cast iron, cast steel or cast light metal.

Tapered roller bearings, tapered roller bearing units and TAROL

Tapered roller bearings are used in the same way as cylindrical roller bearings in the axlebox bearing supports of all types of rail vehicles:

- two single-row tapered roller bearings as a bearing set
- one double-row tapered roller bearing as a ready-to-mount unit

Ready-to-mount units have an integrated seal, are greased and the clearance is adjusted during manufacture.

TAROL units (Tapered Roller Bearing Unit) are also double-row tapered roller bearing units but are available in either metric or imperial dimensions and are supplied with all the necessary retaining elements and fittings. They are mounted on the axle journal using a hydraulic press.



Bearings for Tilting Technology

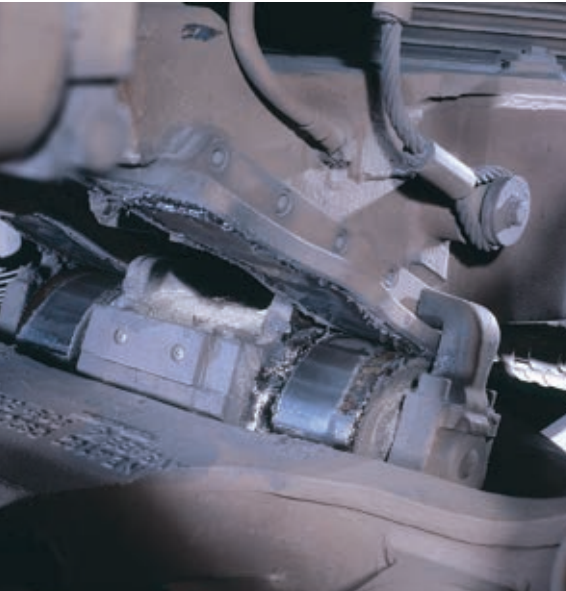

Rail vehicles with tilting technology reach considerably higher speeds on conventional routes than vehicles without tilting technology. This means that journey times are shortened and makes intercity transport more attractive. INA bearings are used in the main tilting mechanism of the rail vehicles, in stabilizing systems such as anti-roll bars and in the drive units for the tilting motion.

Yoke Type Track Roller Units

Yoke type track roller units are complete assemblies consisting of one shaft and two yoke type track rollers. Two yoke type track roller units per bogie support the bogie bolster in each case that, as the main supporting element, enables the tilting motion of the railcar body. The special INA yoke type track rollers are protected against corrosion with Corrotect® and have special seals as effective protection against contamination and have a long operating life.

Cylindrical Roller Bearings with Annular Grooves

The full-complement locating bearings can support not only radial forces but also axial forces in both directions. They can be fixed using annular grooves and are protected against contamination and water spray by lip seals on both sides.

Since the units can be relubricated and they are protected against corrosion with Corrotect®, they present a long-term reliable solution with a high load carrying capacity.

Needle Roller/ Thrust Cylindrical Roller Bearings

These units are used in the drive units for the tilting system and are characterized by a high level of reliability and a long operating life. They consist of an outer ring with radial and axial raceways, two shaft locating washers, an inner ring, a radial needle roller and cage assembly and two thrust cylindrical roller and cage assemblies.

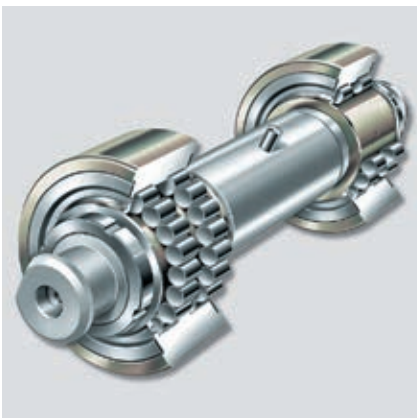

The locating bearings support not only high radial forces but also the axial forces on both sides. They are axially preloaded with INA precision locknuts thereby ensuring clearance-free operation. Needle roller/thrust cylindrical roller bearings are relubricated via the outer ring and can be sealed using a seal carrier assembly. Designs with outer rings suitable for flange mounting are also available.

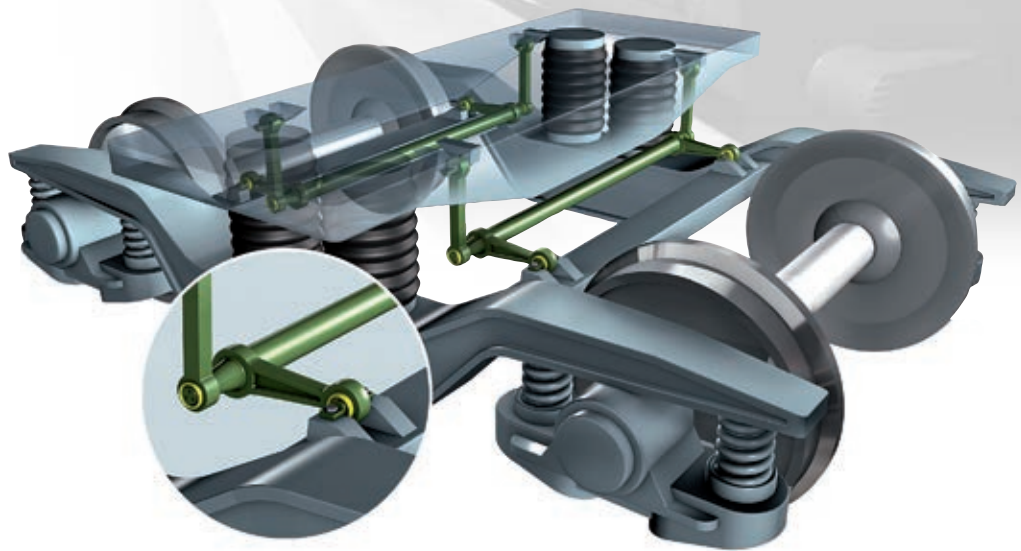

Radial Spherical Plain Bearings

The freedom from maintenance with a long operating life has become increasingly important for spherical plain bearings in railway vehicles. This is why increasing numbers of customers are choosing maintenance-free ELGES spherical plain bearings made by Schaeffler Group Industrial. For example, in smaller dimensions for door systems, medium-size bearings for tilting technology, and larger sizes for couplings. ELGES spherical plain

bearings are characterized by a high load carrying capacity, extraordinary reliability and long life. Maintenance-free standard spherical plain bearings with ELGOGLIDE® sliding fabric are used for the main tilting mechanism of the tilt system that can

achieve a service life of more than 1.2 million kilometers. In highly-dynamic railcar body stabilizing systems (e.g. anti-roll bars), maintenance-free special spherical plain bearings with specially developed bellows are used.

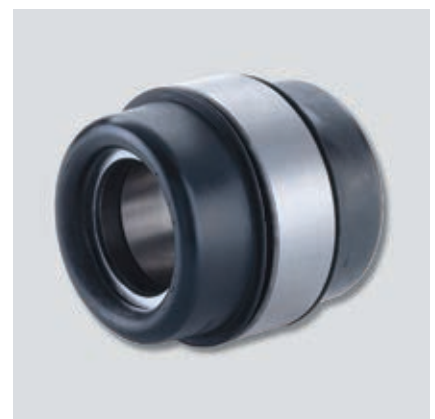
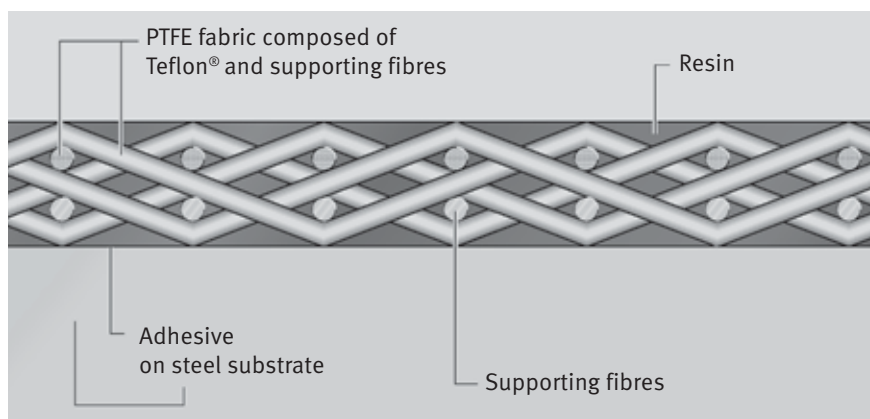

Bearings for Automatic Gage Adjustment Mechanisms



Five different track gages in Europe and Asia still lead to delays for cross-border passenger and freight rail traffic. An automatic gage changeover system provides the solution. Automatic gage changing facilities at stations on borders and adjustable gage wheelsets on the vehicle enable the distance between the wheels on the axle to be adjusted quickly. Schaeffler Group Industrial plain bearings support the gage adjustment mechanism and contribute to extending the maintenance interval of the complex adjustment mechanisms.

Maintenance-free Cylindrical Bushings

Bushings from the Schaeffler ELGES brand with ELGOGLIDE® sliding fabric are used for supporting the wheels that can be axially adjusted along the wheelset axle. These low-friction bushings comprise a steel supporting body on which the ELGOGLIDE® sliding fabric is securely fixed using a moisture-resistant adhesive

bond. These bushings do not require lubricants, have a very high radial load carrying capacity as well as a good damping characteristics. They have already proven themselves in regular service and have an expected operating life of over 500,000 km.

Needle Roller Bearings for Yoke Type Track Rollers

The wheelsets in various gage change-over systems have to be relieved of loads during the gage changing process. This can be carried out by yoke type track rollers that support the entire weight of the railcar during the process. Special yoke type track rollers are used here that are equipped with standard INA bearings. Radial needle roller and cage assemblies support the high radial loads. Thrust needle roller bearings, shaft washers and housing washers are used to support the axial forces on the outer ring of the yoke type track rollers.



Bearings for Brake Systems

Low weight, minimal space requirements, smooth running and reliability are all requirements of modern braking systems in rail vehicles. This is where the advantages of needle roller bearings, drawn cup needle roller bearings with closed ends, thrust needle bearings and drawn cup roller clutches manufactured by the INA brand come into their own and make advanced developments possible.

Needle Roller Bearings

Needle roller bearings are complete units consisting of a machined outer ring and a needle roller and cage assembly. They can also be supplied with removable inner rings if necessary. The low radial section height enables particularly compact designs. They can be relubricated via the outer ring and can also be supplied with seals if required. They are characterized by a high radial load carrying capacity.

Drawn Cup Needle Roller Bearings with Open and Closed Ends

Drawn cup needle roller bearings with open and closed ends consist of thin-walled outer rings and needle roller and cage assemblies and can be supplied with seals if required. They require less space in a radial direction than needle roller bearings. Drawn cup needle roller bearings with closed ends have a closed base that provides protection against moisture and contamination.

Drawn Cup Roller Clutches with Bearing Assembly

Modern brakes have systems for automatically adjusting the brake pad after wear. Drawn cup roller clutches with bearing supports are used as shifting clutches for the adjusting movement in these mechanisms.

Thrust Washers

Thrust washers are used if the adjoining surfaces cannot be used as raceways when using thrust needle roller or cylindrical roller and cage assemblies.

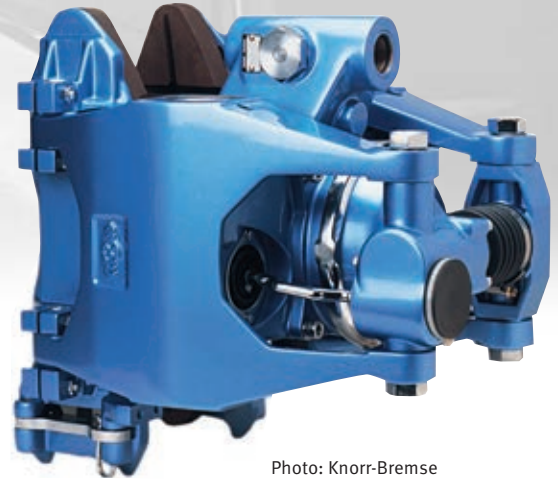

Photo: Knorr-Bremse

They serve as hardened raceways for thrust needle roller and thrust cylindrical roller bearings.

Thrust Needle Roller and Cage Assemblies

Thrust needle roller and cage assemblies consist of a thrust cage and needle rollers. They have a low axial section height and require hardened and ground surfaces as raceways. The bearings can support axial forces in one load direction. Thrust needle roller and cage assemblies have a particularly high axial load carrying capacity as well as high rigidity and can be combined with thrust bearing washers.





The trends are quite clear – the desire for control and monitoring systems continues to rise in passenger rail transportation. At the same time, the intelligence of systems in freight traffic is also increasing. In addition, the unification of European rail networks has also been planned. This is associated with an increase in cross-border traffic, which can already be seen today. The demand for safety requires continuous monitoring of the operating conditions of essential running gear and drive components and therefore mechatronic system solutions.



Axlebox Bearings with Integrated Generators

Axlebox Bearings with Integrated Sensors

Axlebox Bearings with Integrated Generators

If electricity is required in rail wagons, FAG axlebox bearings with integrated generators are the ideal solution. The magnets in the axle cover rotate as a rotor when the wheel axle rotates, whereas the coils in the housing cover stand still and act as a stator. The electricity produced is stored in an accumulator and is also available when the vehicle is standing still. This means that it is possible, for example, for electronic data transmission systems with additional functions such as axlebox bearing diagnosis and hazardous materials monitoring to transfer data in shorter intervals thanks to a continuous supply of electricity. Two systems are currently available: A low-power design with 5 watts as well as a more powerful version with a continuous output of 100 watts. Customer-specific solutions, for example, for voltages from 6 to 24 volts are also available. Installing the generator requires little outlay, since the housing cover and axle cover from a standard housing (UIC or Y25) are simply interchanged with the relevant parts with a fitted generator.

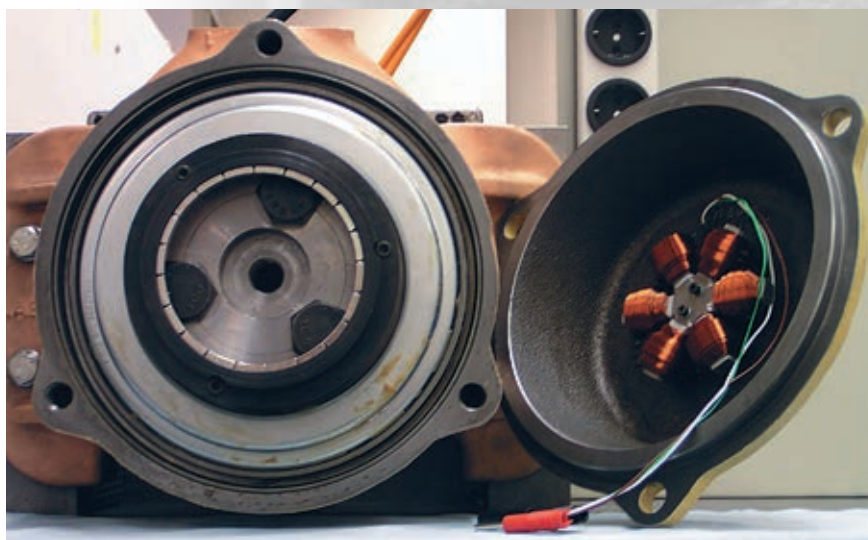

Axlebox Bearings with Integrated Sensors

Schaeffler Group Industrial's engineers have developed an axlebox bearing unit with integrated sensors (bearing with sensors and housing) and optimized it to comply with the requirements of railway applications. The sensors reliably transmit information about speed to the wheel-slide protection and brake systems, speed indicators, and the automatic door-closing mechanisms. Continuous temperature measurements can be used to monitor the condition of the bearings. This enables any problems to be identified early on and rectified in sufficient time. Hot-running recognition systems are also part of the range of services on offer. The sensor system can also permanently generate the required rolling direction information for newly-developed train control systems such as ERTMS/ETCS.

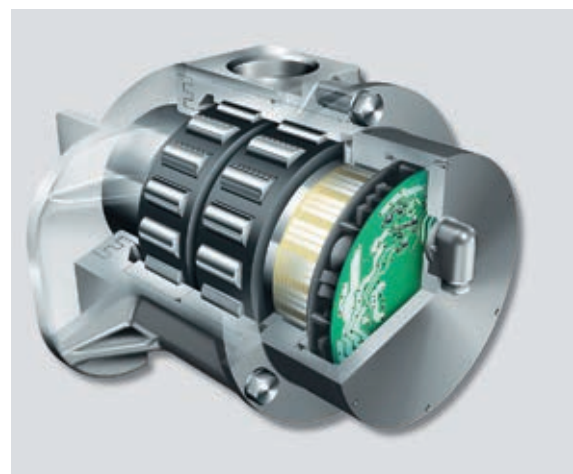



The demand for design in train transport that offers compact and cost-effective solutions for joining vehicle bodywork is higher than ever. For light rail trains in particular, vehicles that are accessible throughout in low-floor and multiple compartment designs are being developed. This facilitates more open cars and enables passengers to board and exit the vehicle more quickly. This requires flexible and compact bearing solutions – bearing solutions from Schaeffler Group Industrial.



Bearings for Connecting Railcar Bodies and Bogies as well as Railcar Bodies with each other

Connectors Between the Railcar Body and the Bogie

The railcar bodies and bogies of modern trams and metros are often connected using slewing rings in four-point contact bearing design. The demands placed on these bearings are various: they are subject to high contamination, vibrations and long operating times. They also have to facilitate long maintenance intervals and be completely reliable. The installation points for mounting and maintenance of these bearings are difficult to access.

INA slewing rings prove themselves under these difficult conditions because of:

- effective seals with improved protection against steam jets
- Corrotect® corrosion protection
- preloaded raceway systems
- special lubricating grease
- and long maintenance intervals

Various special designs, such as designs with additional covers and integrated, adjustable and re-adjustable roll dampers are currently in operation.

Spherical Plain Bearings for Connecting Railcar Bodies

Individual vehicle bodies in many modern rail vehicles are connected by passages that enable passengers to move freely from one railcar to the next. Railcar bodies are connected securely by means of ELGES maintenance-free spherical plain bearings or ELGES rod ends with

ELGOGLIDE® coating. These bearings combine high load carrying capacities under extreme loads (e. g. buffer impact loads in accordance with VDV 152 and EN 12663) with small bearing dimensions, low bearing friction and long operating life.

The upper central joints connect the railcar bodies in the roof. Maintenance-free radial spherical plain bearings or rod ends facilitate the required turning and tilting motions and longitudinal tilts when cornering and traveling uphill and downhill, depending on the overall design.

The lower central joints connect the railcar bodies in the floor area of the vehicle.

These bearings must facilitate all movements when traveling uphill and downhill and safely transfer the acceleration forces between the railcar bodies. In low floor vehicles, they also support the weight of the overlying railcar body (sedan).



Angular contact spherical plain bearings or thrust spherical plain bearings are used for the main bearing support or for the lift-off protector.



Bearings for Connecting Railcar Bodies and Bogies as well as Railcar Bodies with each other

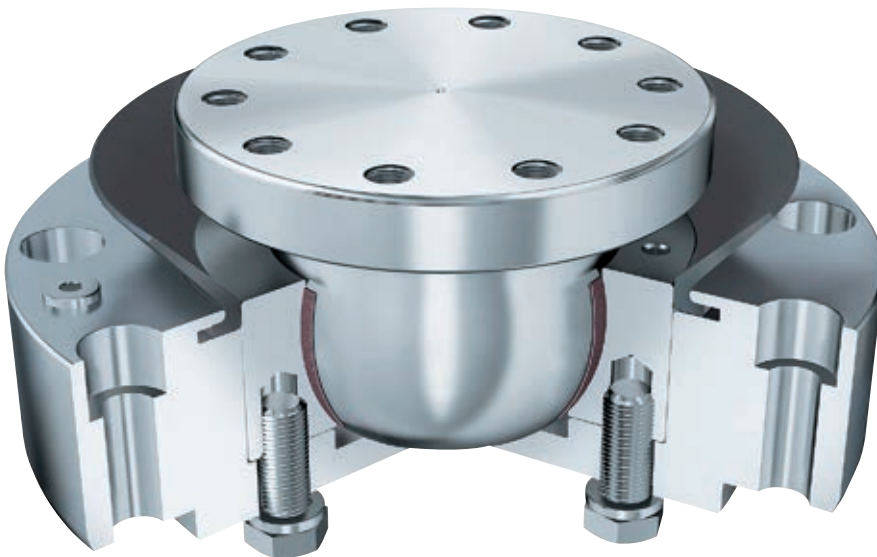

Special Spherical Plain Bearings for the Lower Central Joint

A complete lower central joint unit is an excellent alternative to single components. It considerably simplifies the adjacent structures. The joint is fixed using bolted connectors in the upper and lower housing of the railcar body. The bearing unit itself has an integrated lift-off protector.

Radial Spherical Plain Bearings

Maintenance-free designs with ELGOGLIDE® sliding fabric as well as radial spherical plain bearings that require maintenance with or without rod ends are put into operation for connecting railcar bodies. These bearings can be supplied with corrosion protection and are characterized by high efficiency, long operating life and low friction.

Maintenance-free Rod Ends

Maintenance-free rod ends comprise a spherical plain bearing and a shaft for fixing. They can support loads in a tensile or compressive direction. Maintenance-free designs with an ELGOGLIDE® sliding fabric and corrosion-resistant zinc plating are available.

Thrust Spherical Plain Bearings/ Angular Contact Spherical Plain Bearings

Thrust spherical plain bearings and angular contact spherical plain bearings are the perfect solution for supporting high axial loads. In the maintenance-free design variant with ELGOGLIDE® sliding fabric in particular, they are characterized by above-average efficiency and long operating life.

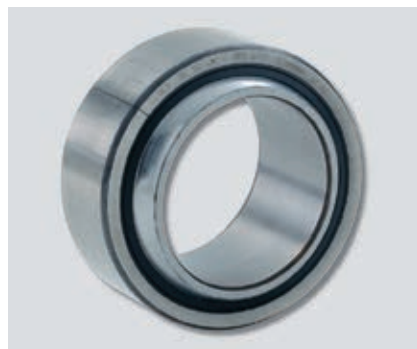
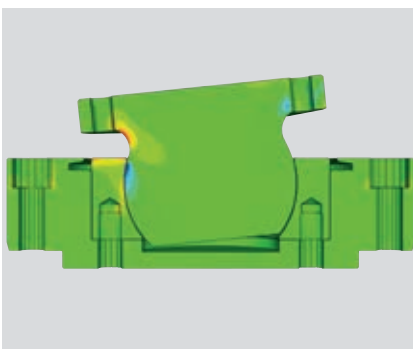

Bearings for Door Systems

Door systems in rail vehicles are complex subsystems that are subject to high stresses. They place high demands on reliability and long maintenance intervals. INA bearing supports fulfill all these demands and are used both in passenger vehicles and freight cars.

Passenger Rail Cars

Vehicle manufacturers demand an operating life of up to more than 2.5 million opening cycles for door systems, depending of the type of rail vehicle. The opening cycle often involves a swiveling outward motion and a linear opening motion of the wings of the door. The swiveling movements are safely carried out with maintenance-free spherical plain bearings and rod ends. Radial insert ball bearings with flange housings are also used in some cases. Linear ball bearings or special track rollers carry out the linear motion.

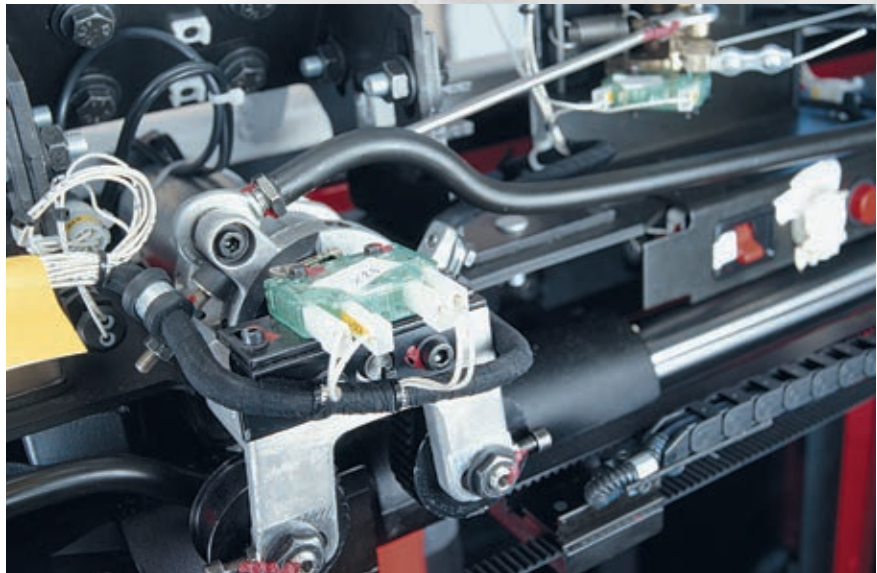

Freight Cars

The focus is on robustness, a long operating life and low maintenance requirements when considering bearing technology in door systems. For example, in sliding wall wagons (HIBBNS,...) and self-discharging cars (FALNS,...), yoke type track rollers, track rollers, needle roller bearings and spherical plain bearings fulfill these high requirements. They are used for the mechanisms of shutters and covers, sliding mechanisms, guidance systems, to support moments as well as linkages and linkage bearing supports.

Linear Ball Bearings

The linear movements in vehicle doors must be carried out reliably. Smooth running INA linear ball bearings with a long operating life and the option of adjusting the angle if required are used here. They compensate misalignment, depending on the design. They require very little space thanks to small dimensions and low radial section height. They are available with or without seals as well as Corrotect® corrosion protection, depending on requirements.



Bearings for Door Systems



Track Rollers, Yoke Type Track Rollers and Stud Type Track Rollers

Track rollers and yoke type track rollers, for sliding wall wagons for example, are complete units consisting of outer rings, inner rings, ball and cage assemblies and seals. Stud type track rollers have an inner ring that comprises a stud, with which the bearing is fixed to the adjacent construction. These INA products are characterized by high load carrying capacity, efficient seals and long operating times. Corrotect® corrosion protection increases operating life. Plastic-covered outer rings can be supplied to reduce noise, if required. When various track rollers are in use, the pressure on the mating track surface is considerably reduced by the special INA profile. Special outer ring contours are available that are particularly well-suited to the special environmental conditions.

Radial Spherical Plain Bearings/Rod Ends

Maintenance-free ELGES spherical plain bearings and rod ends with corrosion protection are frequently used in the bearing supports of doors in passenger rail cars. They can also be found in wagons for bulk freight where severe contamination from dust and dirt occurs. Here, they are used as reliable, maintenance-free bearing supports for camlock shafts, tilting rods and shutters. Split radial spherical plain bearings guide the camlock shafts in freight cars. They are characterized by long operating times and their higher resistance to contamination and insufficient lubrication. A further advantage is the fact that they can be easily replaced between the locking disc cams. The disc cams do not have to be removed from the locking shaft, which is several meters long. The split outer and inner rings make initial mounting and replacement considerably easier.

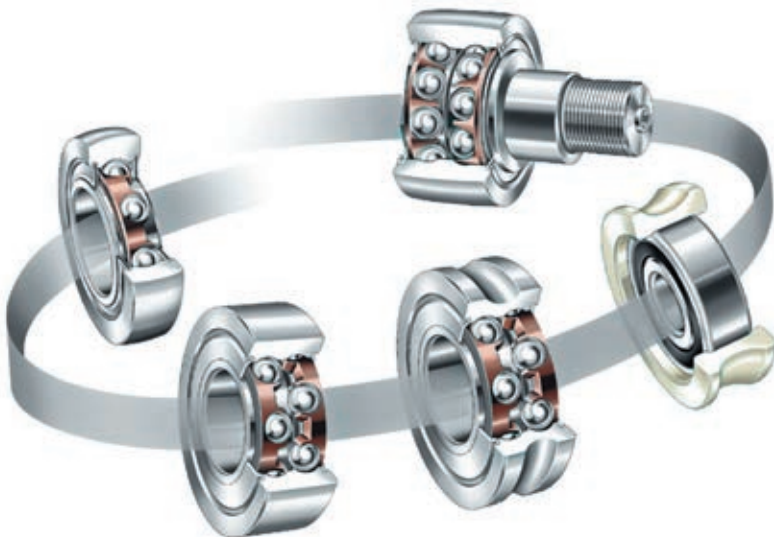

Examples of Application



Schaeffler Group Industrial, known for its brands INA and FAG, develops reliable bearing systems in close cooperation with rail vehicle manufacturers and operating companies that are tailor-made to customer requirements. More than 100 years' experience in this area ensures the highest quality and perfect optimization for any application. Various bearing solutions for local transportation, for vehicles in regional, intercity, high-speed and freight transportation constantly prove themselves during operation.

Examples of Application



FAG Axlebox Bearings with Swing-arm Housing in the CORADIA LIREX for Stockholm

An axlebox bearing with a swing-arm housing was designed for the bogie concept of ALSTOM LHB. It consists of a cap and base, housing ring and a rolling bearing. The rolling bearings, in this case cylindrical rolling bearings, are mounted into a separate housing ring. The cylindrical roller bearings are single bearings mounted in the proven NJ-NJP arrangement. The bearings are state-of-the-art, fitted with a polyamide cage and manufactured to EN 12080.



FAG Insert Hub Units for Trams in Halle

Continuous axlebox shafts cannot be installed in trailer bogies due to the low-floor section. This means that low floor axles are used where the wheels are mounted on a stationary axle. All trams for the city of Halle have FAG insert hub units for the independent wheels. FAG insert hub units consist of a tapered roller bearing pair. The inner rings of both bearings are manufactured with such high precision that the specified preload is obtained in the wheel unit after mounting.



Photo: Bombardier

FAG Rolling Bearings in the Wheelsets, Gearboxes and Current Collectors of the MOVIA Vehicles for London Underground

Bombardier Transportation is developing and building 47 new eight-car subway trains for Metronet Rail for the Victoria line of the London Underground system. Both *Bombardier* MOVIA** pre-series trains are equipped with FAG axlebox bearings as well as FAG rolling bearings for current collectors and gearboxes. All motor bogies and carrying bogies are equipped with axlebox housings of type AMG100-T and rolling bearings of type TAROL100/175. The double-stage helical gear is manufactured by Wateeuw and supported entirely by FAG rolling bearings.

*Trademark of Bombardier Inc. or subsidiary





FAG Gearbox, Axlebox and Traction Motor Bearings in the BR 185

In the late nineties, Bombardier in Kassel developed the Class 185 locomotives, a multi-system version for fast, cross-border freight services. They are a further development of the Class 145. The BR 185 locomotives can operate in Germany, Austria, Switzerland, France, Luxemburg and Denmark. DB Railion (formerly DB Cargo) placed an order for 400 Class 185 locomotives. Schaeffler Group Industrial has been the exclusive supplier of the gearbox and traction motor bearings for the BR 185 since 1995. FAG has also been supplying the axlebox bearings and housings since 2004.

FAG Traction Motor Bearing Supports and ELGES Spherical Plain Bearings in the Combino® Low-floor Articulated Railcar

Schaeffler Group Industrial supplies the current insulated bearings for the traction motors for the Combino low-floor articulated railcars developed by Siemens and supplies the bearings for the vehicle central joints. The individual railcar bodies are joined by central joints. The lower central joint (angular contact spherical plain bearing) transmits all dynamic and static loads of the railcar body and “sedans” (without its own bogie). The upper central joint (radial spherical plain bearing) ensures that the railcar body does not tilt away to the side.

FAG TAROL Axlebox Bearings, FAG Traction Motor and Gearbox Bearings for the American Flyer

ACELA Express is the name given to the new high-speed trains in America developed by a consortium between Bombardier Transportation (Canada) and Alstom (France). The trains are operated by AMTRAK and have been running since the end of 1999 on the Northeast Corridor (NEC), the connection between Boston and New York with speeds of up to 240 km/h. 15 electric locomotives were purchased for traditional electrified lines, alongside 18 electric multiple units. FAG supplies the axlebox bearings, traction motor bearings and gearbox bearings for the power cars and the locomotives.

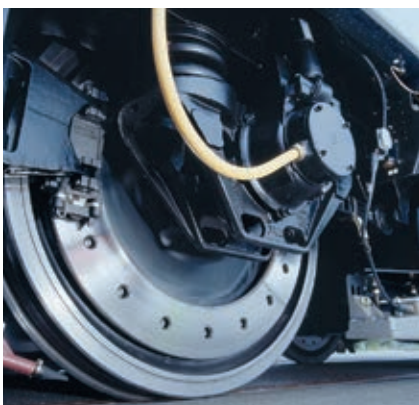



Photo: Alstom/Massimo Sfreddo

ELGES Spherical Plain Bearings in the Tilting System and FAG Gearbox Bearings of the New PENDOLINO

Starting in November 2006, 12 seven-car trains will be added to the fleet of 40 PENDOLINOs and 60 ETR 500 trains that already operate on the high-speed lines of Trenitalia. The 14 train compositions for Cisalpino are, among others, intended for cross-border traffic between Italy and Switzerland. Schaeffler Group Industrial supplies all trains with spherical plain bearings for the railcar body stabilizing systems and the main tilting mechanisms as well as complete bearing sets for the gearboxes.



Photo: Stadler Bussnang AG

FAG Gearbox Bearings in the Montserrat Rack Railway

The old rack railway line that runs to the monastery of Montserrat has been put back into operation. The wheelset drives of the five type GTW Beh 2/6 vehicles from Stadler Bussnang AG are equipped with FAG rolling bearings. The trains are equipped with a “mixed drive” for adhesion operation and rack railway operation. The drive motor and the rack and pinion drive form a unit which is supported on the drive shaft via two cylindrical roller bearings and is suspended from the bogie frame near the center of the bogie. The driving pinion and the drive wheels for adhesion operation are driven via two gear steps.



FAG TAROL Units in the “Rolling Highway”

Eight-axle Saadkms type “piggyback” flat rail wagons are used by various railway companies, e.g. Hupag (Switzerland) and the ÖBB (Austria) for transalpine transport of heavy goods vehicles. Schaeffler Group Industrial supplies axlebox bearings and housing adapters for the bogies of the flat rail wagons. The wheelsets are each supported by two TAROL units with lamellar ring seals.

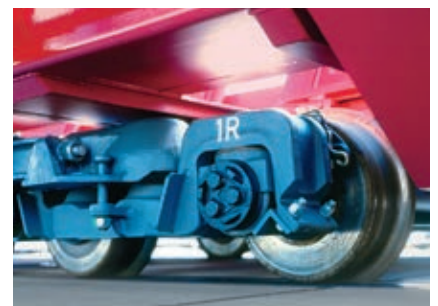

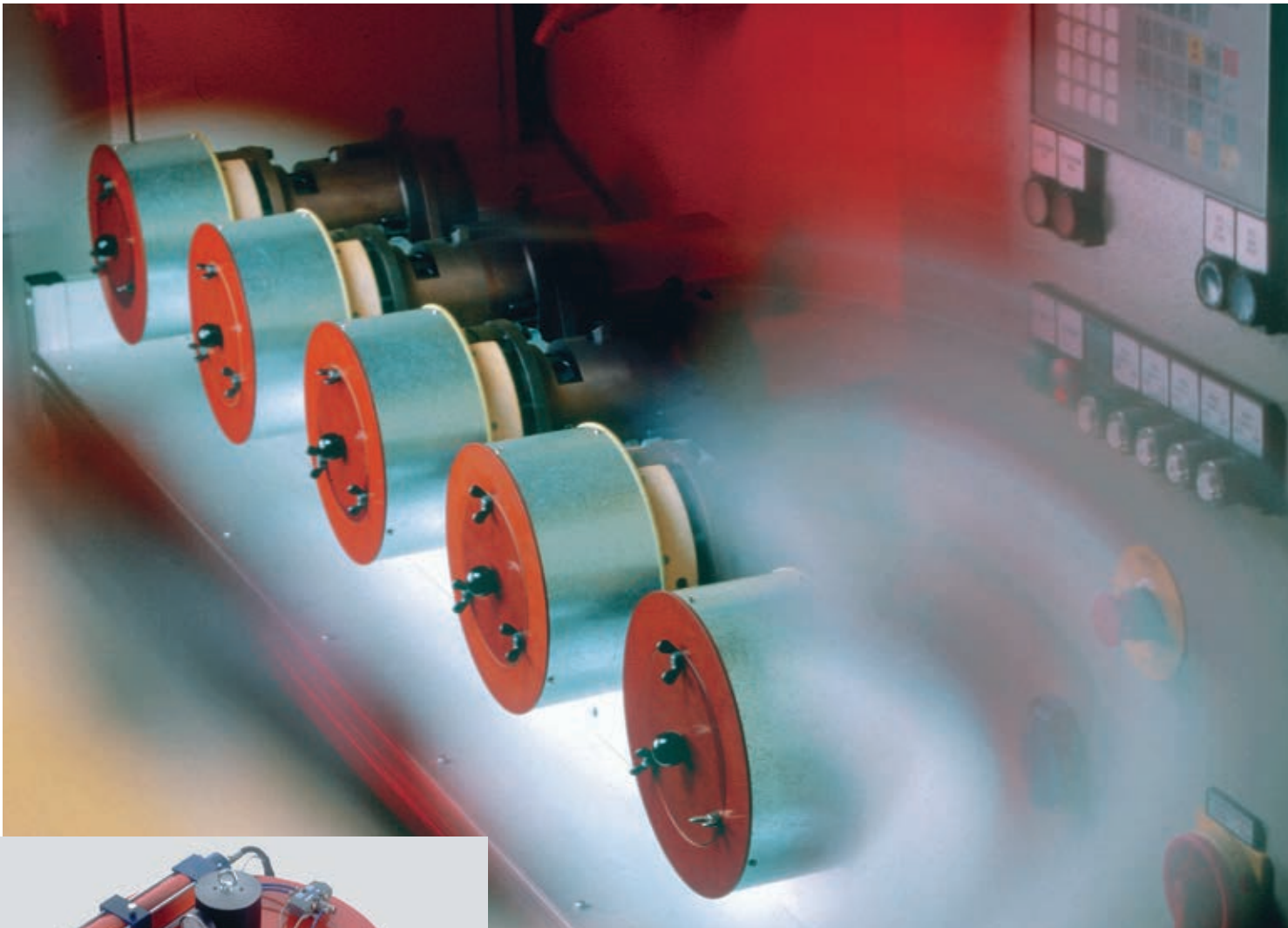

From a safety aspect, railway bearings are among the most important components found in rail vehicles due to the high loads involved. Schaeffler Group Industrial is committed to providing service that accompanies the product throughout the entire life cycle. Bearings and housings are calculated using state-of-the-art methods as early on as the development and design phases so that they can subsequently be optimized on test rigs developed in-house. Professional mounting, suitable tools, the correct lubricants as well as the comprehensive range of services offered by FAG Industrial Services (FIS) ensure long operating life for all INA and FAG products.

Testing Center and Test Rigs



The function of completely assembled bearings as well as specific individual components and materials is tested in our Schweinfurt plant, in a facility covering approximately 7,000 m². Around 700 orders are completed annually on 100 different types of test rigs developed in-house for bearings of various designs and sizes.

The reliability of the bearings under extreme conditions is tested on the railway bearing test rigs. Special axlebox bearing test rigs are used to test the bearings according to DIN EN 12082. The test rigs simulate running speeds of up to 550 km/h and wind speeds of up to 180 km/h. These tests have led to considerable increases in the operating life and maintenance intervals of the rolling bearings. A kilometer reading of 1.2 million kilometers, depending on the operating conditions, is standard today for bearings in main-line railway vehicles.

Test Rig for Wheelset Workshops

This new wheelset test rig offers special benefits to the customer. Due to its design, the bearings no longer have to be dismounted to be tested, which saves time. Rolling bearing diagnostics is carried out by means of structure-borne sound (vibration generated when rolling over damaged areas).

By measuring the vibrations in the axlebox bearings, it is possible to recognize any occurring fatigue or cracks in the raceways or the rolling elements. Measurements and measurement data analysis is carried out by a computer-assisted rolling bearing diagnosis system. The measurement results are stored on a computer and can be compared later during subsequent checks carried out on the same wheelset.

FAG FE8 Lubricant Test Rig

FE8 lubricant test rig for preselecting and testing greases and oils according to DIN 51819, part of EN 12081.

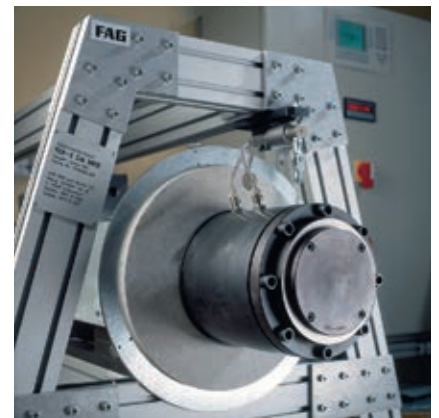
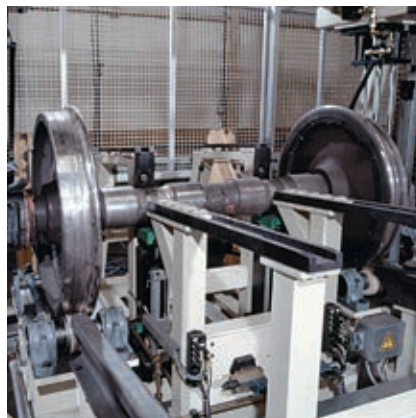

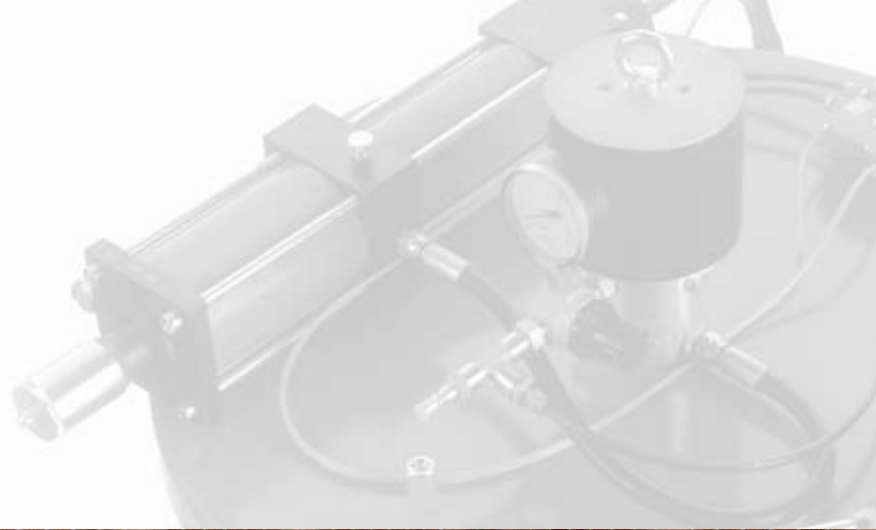

AN46 Universal Test Rig

By using the AN46 test rig, it is possible to simulate entire line profiles and therefore analyze the impacts of all significant influencing factors on the axlebox bearings. Double-row tapered roller bearings or cylindrical roller bearings in their original housings are mainly tested. The operating temperature and the grease service life reached are the fundamental test criteria. Due to the fact that the cooling of the axlebox bearing housing and therefore the bearing caused by air flow has a considerable effect on the grease service life, the AN46 test rig was fitted with an air flow simulator that can create wind speeds of up to 180 km/h. Additional structure-borne sound monitoring detects possible damage during operation and provides information about lubrication. The AN46 test rig means that the railway testing center at the Schweinfurt location has the expertise to carry out tests for “performance testing for axlebox bearings – railway applications” as an independent laboratory in accordance with DIN EN ISO/IEC 17025:2000, certified by DAP (German Accreditation System for Testing).

AN55 and AN55D Standard Test Rig

The AN55 has a simpler design in comparison to the AN46 universal test rig. It offers cost-effective testing in cases where long-distance travel need not be simulated and where air stream simulation of up to 10 meters/second is sufficient.



The test rig is operated with a constant radial load and changing axial load and provides measurement results for radial and axial loads, temperature and noise. Again, the AN55 test rig is certified in accordance with DIN EN ISO/IEC 17025:2000 for independent “performance testing for axlebox bearings – railway applications”.

In addition, the AN55D test rig is used to check whether the axlebox bearings are impermeable to water spray (required in UIC standard 515-5). The test involves spraying the axlebox bearing continuously with water both while standing still and when simulating various transportation speeds. No water should permeate the bearing after the various stages of the test.



Mounting, Tools and Lubricants



The prerequisites for long operating life are care and cleanliness during mounting, suitable mounting and dismantling tools and the correct maintenance accessories. Special rolling bearing greases ensure that bearings from INA and FAG remain efficient over a long period of time.



Mounting and dismantling tools and mounting accessories such as:

- heating equipment
- extraction devices
- high-pressure pumps for hydraulic mounting methods
- fitting devices
- multi-plate presses
- visual inspection devices, and so on

Lubrication and grease:

- FAG Arcanol rolling bearing grease
- FAG grease metering device

Condition monitoring, support and rolling bearing service, e. g.:

- maintenance support
- on-site mounting service
- online monitoring
- measurement campaigns
- training
- documentation



Railway Bearing Maintenance

Regular professional maintenance increases the lifetime considerably. Therefore, FIS provides operators of all types of rail vehicles with professional dismounting, cleaning, and reconditioning of railway bearings. The high quality of our maintenance operations and the expertise of the members of our reconditioning team offer increased safety for your rail vehicles.

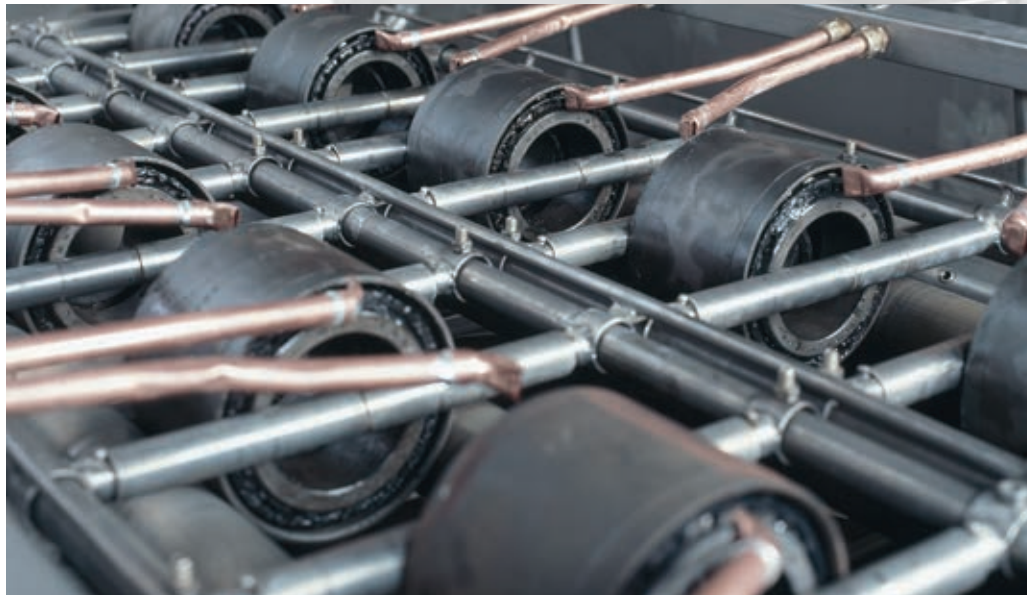

Services comprise:

- professional dismounting, cleaning and reconditioning of railway bearings
- signing of every single bearing prior to dismounting
- if required, documentation of all maintenance work performed for every bearing

We offer:

- years of extensive experience in the production of railway bearings
- state-of-the-art equipment with specially-developed tools for dismounting and
- mounting as well as the required devices for cleaning bearings

- customized solutions and a range of services perfectly matched to your requirements
- consistent quality of our lubricants through extensive testing prior to filling

Preventative maintenance significantly reduces bearing maintenance costs.



Quality Management and Certification



Quality originates during the production process

No INA or FAG product leaves the plant without undergoing stringent quality control inspections. All procedures are described in the quality manual and certified according to DIN EN ISO 9000 and TS 16949. However, one can only test what one has produced. This is particularly true of the quality of our own bearings and their components. In other words, quality originates during the production process and not during checks made later on. Schaeffler Group Industrial is a certified partner and supplier to Deutsche Bahn AG, AAR, SNCF and other operators and organizations. This means that products from INA and FAG meet the increasingly complex operating requirements and high safety standards for railway vehicles.

DAP Certificate

Schaeffler Group Industrial has test rigs for testing the performance of axlebox bearings in railway applications in the railway test facility at the Schweinfurt location. These test rigs enable test runs to be carried out in accordance with the requirements of European standard EN 12082.

This standard describes basic principles and procedures for testing the performance of assembled axlebox bearings on test rigs. The axlebox bearing function is tested according to EN 12082 in order to provide evidence of the bearing's suitability for operation.

The management system of our railway test facility complies with the requirements of EN/ISO 17025, an international standard that defines the specifications required of an organization for carrying out these tests. During the accreditation process, the DAP (German Accreditation System for Testing) accredited that the railway test facility at the Schweinfurt location fulfills these requirements and that the company's technical and specialist expertise enables it to obtain substantiated results. This accreditation permits the railway test facility to carry out these tests as an independent laboratory and present the results accordingly. Mutual recognition agreements with equivalent facilities in other countries means that the DAP accreditation is recognized all over the world.





More literature concerning INA and FAG products and services for rail vehicles as well as selected examples of application engineering (publication number WL 07 506 onwards) can be found in the libraries of the homepages www.ina.com and www.fag.com.

Schaeffler Technologies AG & Co. KG

Georg-Schaefer-Strasse 30
97421 Schweinfurt
Germany

Internet www.schaeffler.com
E-Mail rail_transport@schaeffler.com
Phone +49 9721 91-3998
Fax +49 9721 91-3788

Every care has been taken to ensure the correctness of the information contained in this publication but no liability can be accepted for any errors or omissions. We reserve the right to make technical changes.

© Schaeffler Technologies & Co. KG
Issue: 2015, July

This publication or parts thereof may not be reproduced without our permission.